

CUSTOMER PRINT

PART NUMBER: 3282-XPG-3XX(CCX)

- NOTES:
 1. ALL PARTS TO BE BULK PACKED.
 2. CONTACTS TO BE INSERTED INTO CONNECTOR

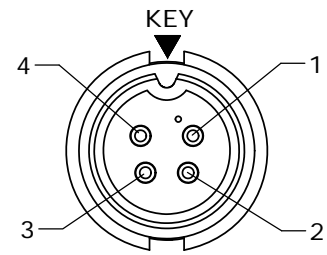

FACE VIEW

ASS'Y: 3282-4PG-3XX

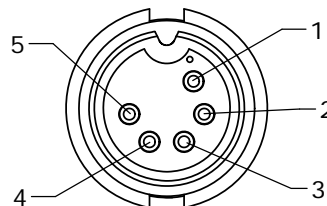

FACE VIEW

ASS'Y: 3282-5PG-3XX

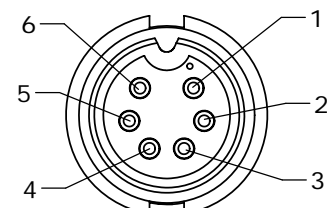

FACE VIEW

ASS'Y: 3282-6PG-3XX

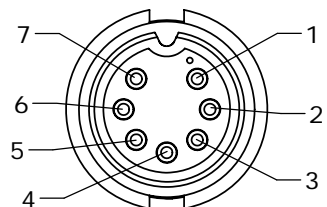

FACE VIEW

ASS'Y: 3282-7PG-3XX

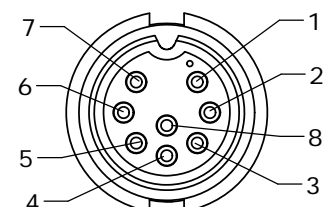

FACE VIEW

ASS'Y: 3282-8PG-3XX

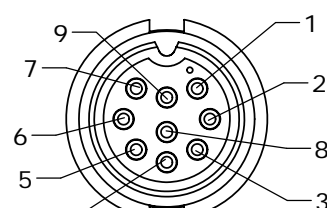

FACE VIEW

ASS'Y: 3282-9PG-3XX

KIT P/N	GROMMET SIZE
3282-XPG-3DC	DAISY CHAIN
3282-XPG-315	CABLE O.D. .15-.17 [3.8-4.3mm]
3282-XPG-318	CABLE O.D. .18-.20 [4.6-5.1mm]
3282-XPG-321	CABLE O.D. .21-.23 [5.3-5.8mm]
3282-XPG-324	CABLE O.D. .24-.27 [6.1-6.9mm]
3282-XPG-328	CABLE O.D. .28-.29 [7.1-7.4mm]
3282-XPG-330	CABLE O.D. .30-.32 [7.6-8.1mm]

KIT P/N	NO. OF CONTACTS
3282-4PG-3XX	(4)-#20
3282-5PG-3XX	(5)-#20
3282-6PG-3XX	(6)-#20
3282-7PG-3XX	(7)-#20
3282-8PG-3XX	(8)-#20
3282-9PG-3XX	(9)-#20
3282-XPG-3XX	

GROMMET SIZE FOR SINGLE GROMMET, OR "DC" FOR DAISY CHAIN

NO OF CONTACTS

ASS'Y P/N	COUPLING RING COLOR
3282-XPG-3XXCC1	WHITE
3282-XPG-3XXCC2	RED
3282-XPG-3XXCC3	BLUE
3282-XPG-3XXCC4	LIGHT GREY
3282-XPG-3XXCC5	YELLOW
3282-XPG-3XXCC6	MAROON
3282-XPG-3XXCC7	GREEN

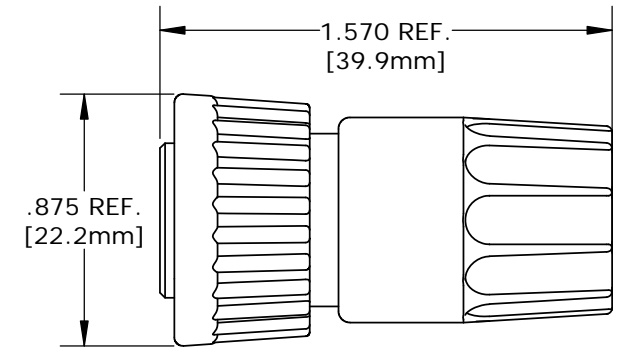
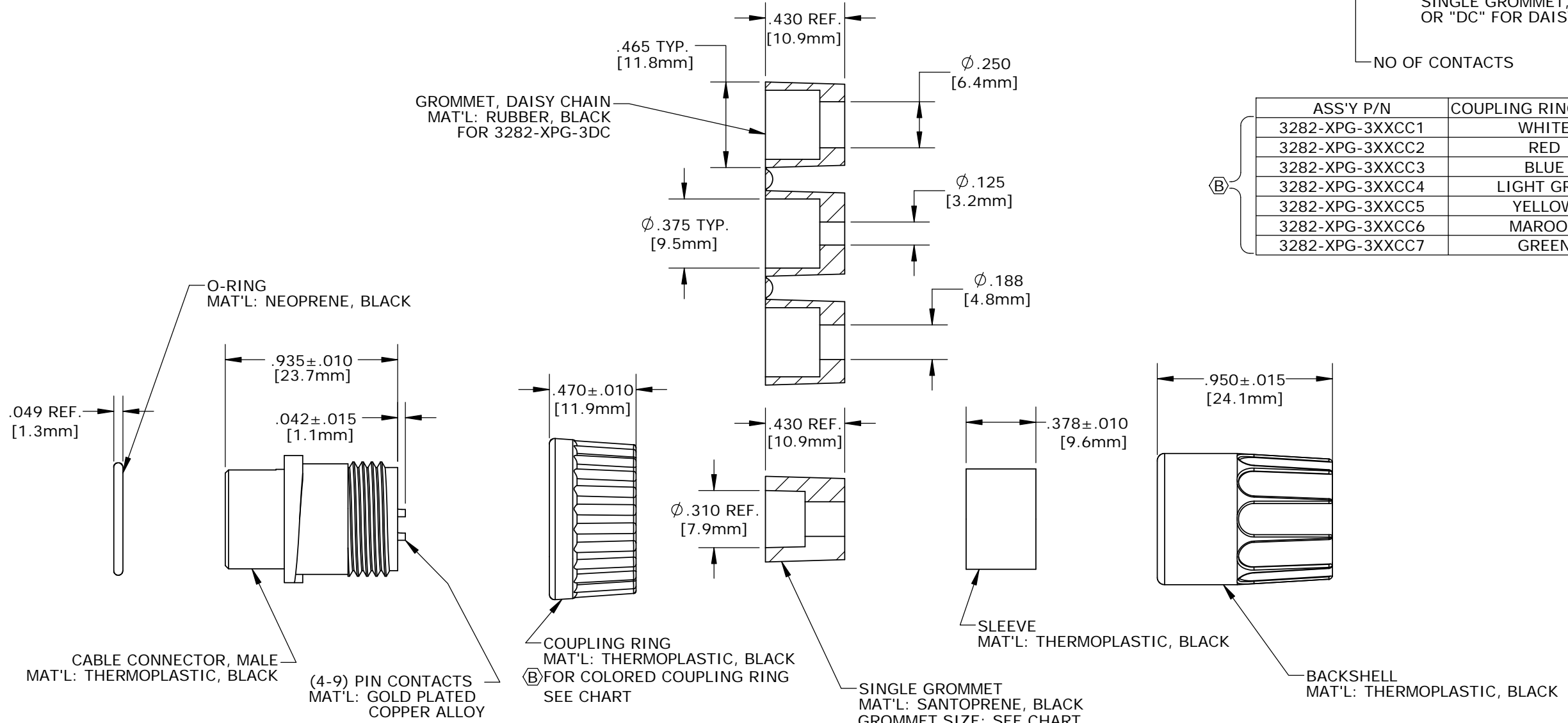

SHOWN ASSEMBLED KIT
FOR CUSTOMER REFERENCE ONLY

DIMENSIONS IS BRACKETS [] ARE METRIC

CUSTOMER APPROVAL

THIS DOCUMENT CONTAINS CONFIDENTIAL INFORMATION PROPRIETARY TO CONXALL CORPORATION. ANY REPRODUCTION, DISCLOSURE, OR USE OF THIS DOCUMENT /INFORMATION IS EXPRESSLY PROHIBITED UNLESS AUTHORIZED IN WRITING BY CONXALL CORPORATION.

APPROVED BY: _____
 DATE: _____

B	SS	04-08-19	ADDED COUPLING RING COLOR CHART TO DRAWING PER DOR 19-E149SL #4
A	AN	03-07-13	DRAWING CREATED PER DOR 13-E149SL #9
REV.	INIT.	DATE	DESCRIPTION
ALL INFORMATION ILLUSTRATED IS THE PROPERTY OF CONXALL CORPORATION. UNAUTHORIZED DUPLICATION OR DISTRIBUTION OF THIS DOCUMENT IS PROHIBITED.		ORIG. DRAWN BY: AN	DATE: 03-06-13
ALL UNITS ARE IN FEET, INCHES, FRACTION OF INCHES AND DECIMALS.		CHECKED BY:	<p>601 E. WILDWOOD VILLA PARK, IL 60181</p>
SCALE	SIZE	SHEET	
NTS	B	1 OF 1	TITLE: CABLE CONNECTOR KIT (4-9) #20 PIN CONTACTS, SOLDER MULTI-CON-X STANDARD PRODUCT
FILE: 3282-XPG-3XX(CCX)	DIRECTORY: SLW	PART NUMBER: 3282-XPG-3XX(CCX)	REV B

RoHS COMPLIANT