

CUSTOMER PRINT

PART NUMBER: 3282-XSG-5XX(CCX)

- NOTES:**
1. ALL PART TO BE BULK PACKED
 2. CONTACTS ARE ASSEMBLED INTO CONNECTOR AS SHOWN
 3. ALL DIMENSION ARE REFERENCE EXCEPT THOSE WITH A TOLERANCE

ASS'Y P/N	COUPLING RING COLOR
3282-XSG-5XXCC1	WHITE
3282-XSG-5XXCC2	RED
3282-XSG-5XXCC3	BLUE
3282-XSG-5XXCC4	LIGHT GREY
3282-XSG-5XXCC5	YELLOW
3282-XSG-5XXCC6	MAROON
3282-XSG-5XXCC7	GREEN

CONN. KIT P/N	NO. OF CONTACTS
3282-4SG-5XX	4-#20
3282-5SG-5XX	5-#20
3282-6SG-5XX	6-#20
3282-7SG-5XX	7-#20
3282-8SG-5XX	8-#20
3282-9SG-5XX	9-#20

CONN. KIT P/N	GROMMET FOR CABLE	"X" DIM.
3282-XSG-5DC	SEE DAISY CHAIN	Ø 0.77 [19.6mm]
3282-XSG-515	.156 I.D. FOR CABLE .15-.17 O.D. [3.8-4.3mm]	Ø 0.77 [19.6mm]
3282-XSG-518	.187 I.D. FOR CABLE .18-.20 O.D. [4.6-5.1mm]	Ø 0.77 [19.6mm]
3282-XSG-521	.225 I.D. FOR CABLE .21-.23 O.D. [5.3-5.8mm]	Ø 0.77 [19.6mm]
3282-XSG-524	.250 I.D. FOR CABLE .24-.27 O.D. [6.1-6.8mm]	Ø 0.77 [19.6mm]
3282-XSG-528	.285 I.D. FOR CABLE .28-.29 O.D. [7.1-7.4mm]	Ø 0.77 [19.6mm]
3282-XSG-530	.312 I.D. FOR CABLE .30-.32 O.D. [7.6-8.1mm]	Ø 0.77 [19.6mm]
3282-XSG-535	.375 I.D. FOR CABLE .35-.40 O.D. [8.9-10.2mm]	Ø 0.83 [21.1mm]

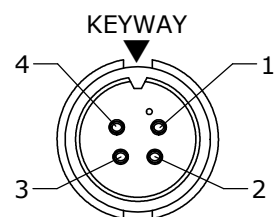

FACE VIEW
P/N: 3282-4SG-5XX

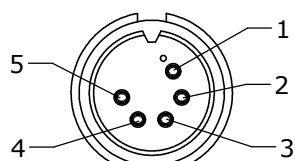

FACE VIEW
P/N: 3282-5SG-5XX

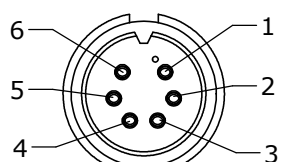

FACE VIEW
P/N: 3282-6SG-5XX

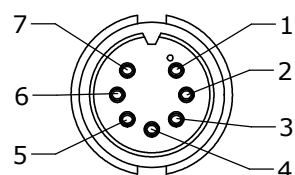

FACE VIEW
P/N: 3282-7SG-5XX

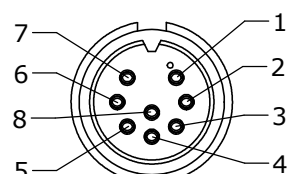

FACE VIEW
P/N: 3282-8SG-5XX

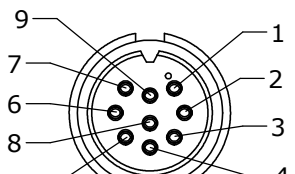

FACE VIEW
P/N: 3282-9SG-5XX

GROMMET SIZE FOR SINGLE GROMMET OR "DC" FOR DAISY CHAIN SEE LIST

NO OF CONTACTS

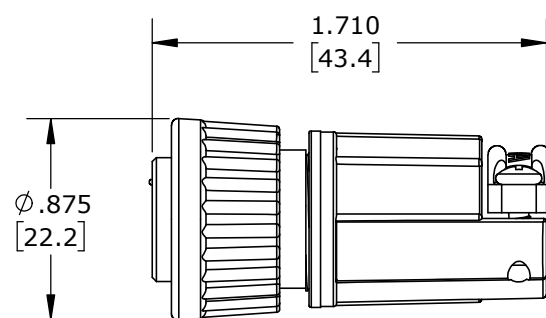
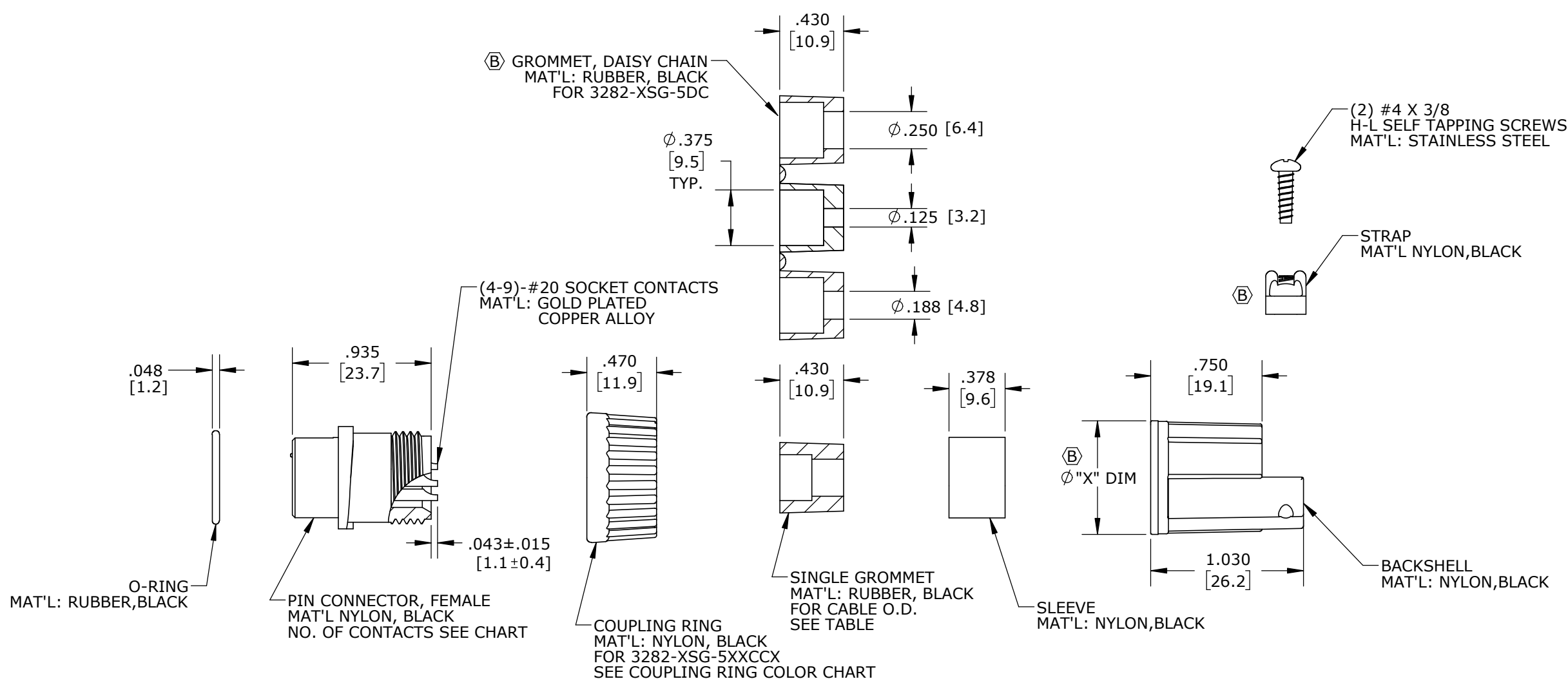

ASSEMBLED VIEW
FOR CUSTOMER REFERENCE

DIMENSIONS IN BRACKETS [] ARE METRIC

CUSTOMER APPROVAL

THIS DOCUMENT CONTAINS CONFIDENTIAL INFORMATION PROPRIETARY TO CONXALL CORPORATION. ANY REPRODUCTION, DISCLOSURE, OR USE OF THIS DOCUMENT /INFORMATION IS EXPRESSLY PROHIBITED UNLESS AUTHORIZED IN WRITING BY CONXALL CORPORATION.

APPROVED BY: _____
DATE: _____

RoHS COMPLIANT

REV.	INIT.	DATE	DESCRIPTION
B	AN	03-22-21	DRAWING P/N WAS 3282-XSG-5XX. ADDED COUPLING RING TABLE AND DAISY CHAIN GROMMET VIEW ADDED 3282-XSG-535, -5DC AND "X" DIM. TO CHART, UPDATED STRAP STYLE. PER ECR 9543
A	AN	08-08-11	DRAWING CREATED PER DOR 11-E149SL

ALL INFORMATION ILLUSTRATED IS THE PROPERTY OF "CONXALL CORPORATION". UNAUTHORIZED DUPLICATION OR DISTRIBUTION OF THIS DOCUMENT IS PROHIBITED.	ORIG. DRAWN BY: AN DATE: 07-29-11	<p>601 E. WILDWOOD VILLA PARK, IL 60181</p>
ALL UNITS ARE IN FEET, INCHES, FRACTIONS OF INCHES AND DECIMALS.	CHECKED BY:	
	APPROVED BY:	TITLE: CONNECTOR ASS'Y KIT (4-9) #20 SOCKET CONTACTS (SOLDER) MULTI-CON-X
	SCALE: NTS SIZE: B SHEET: 1 OF 1	CUSTOMER: STANDARD PRODUCT
	FILE: 3282-XSG-5XX(CCX) DIRECTORY: SLW	PART NUMBER: 3282-XSG-5XX(CCX) REV B