

**NOTES:**

1. MATERIALS:  
HOUSING - THERMOPLASTIC, BLACK  
TERMINALS - COPPER ALLOY, GOLD PLATED
2. SUPPLIED ON TAPE AND REEL, SEE SHEET 2.
3. THIS PRODUCT IS RoHS COMPLIANT.

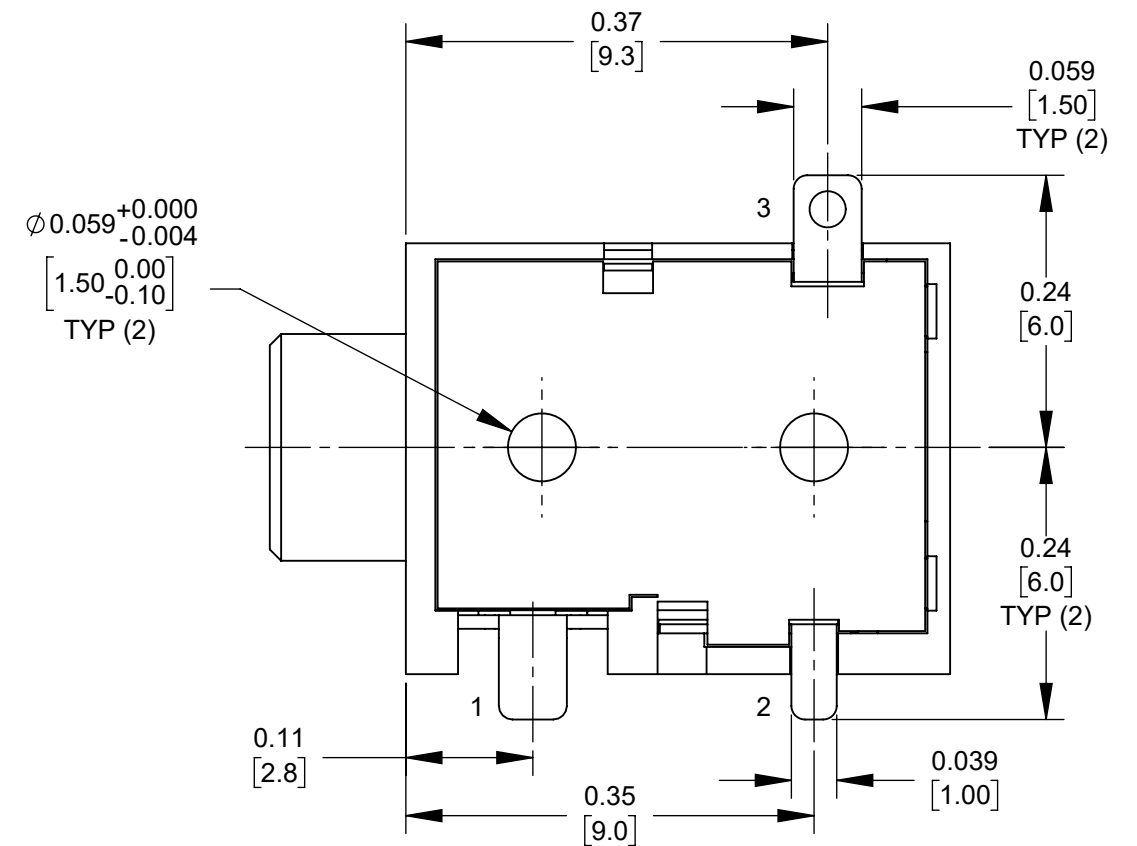

**CUSTOMER DRAWING**

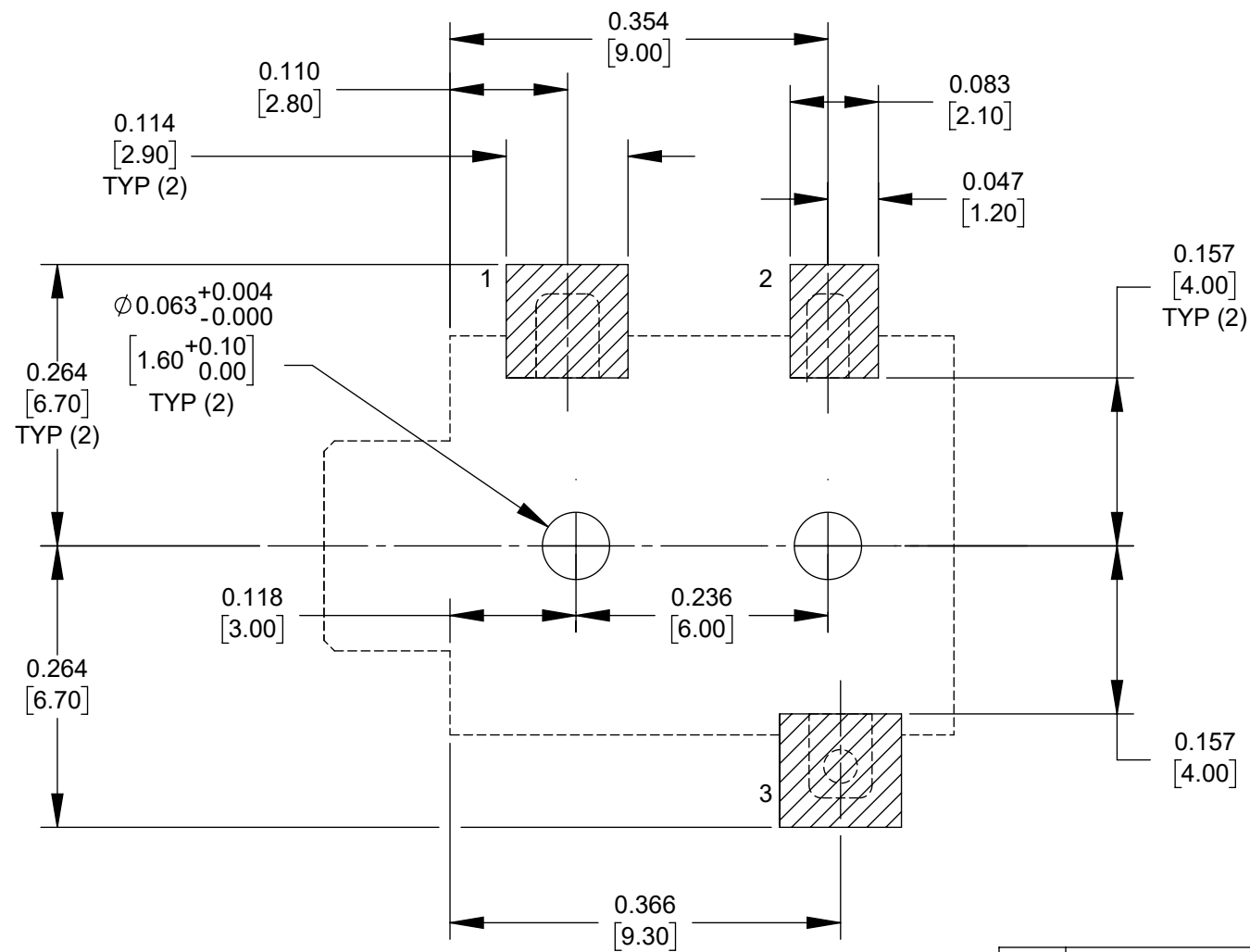
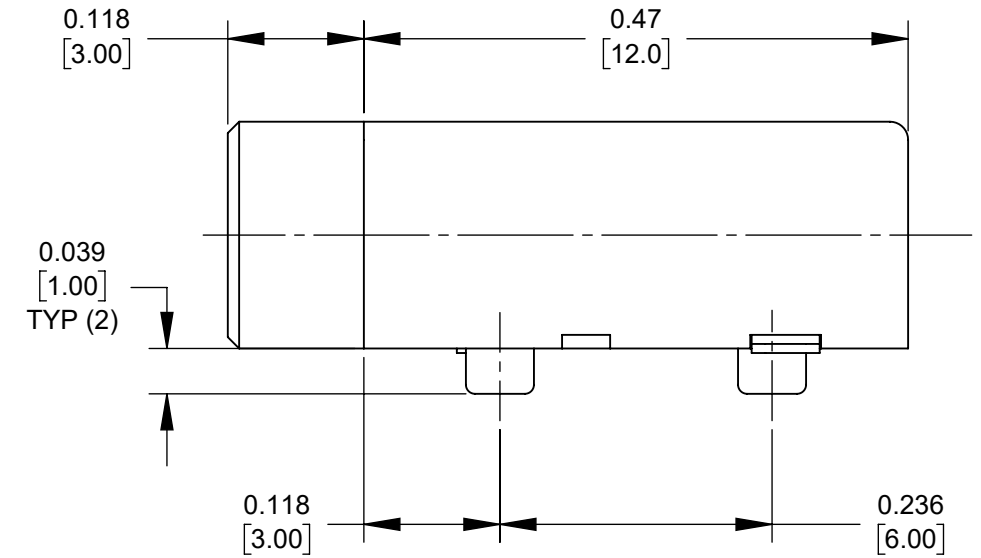
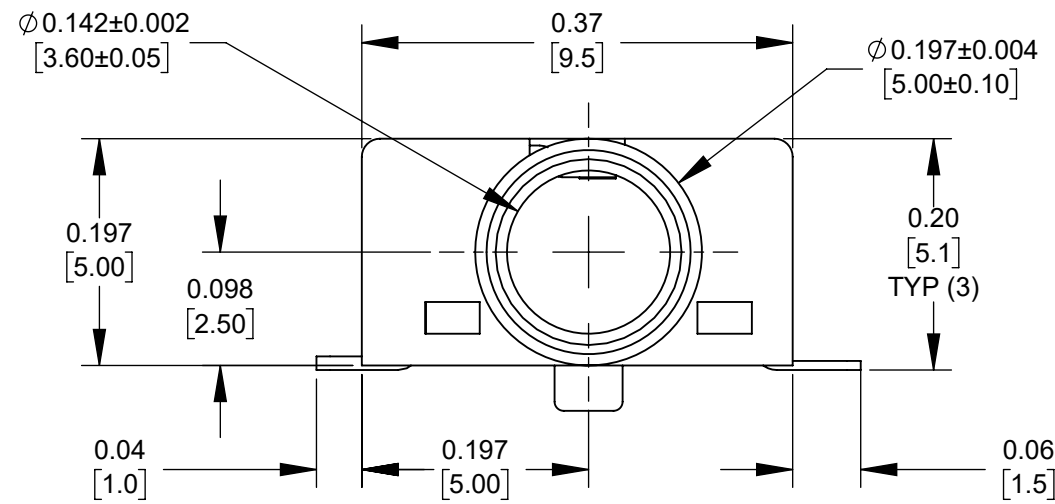
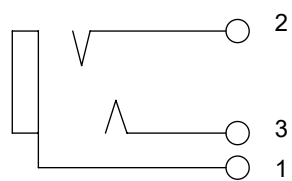

**SCHMATIC**

**PCB LAYOUT  
COMPONENT SIDE**

REV	ECO NUMBER	DATE	BY	APVD
A	28463	01/31/22	PC	TJK
REVISIONS				

UNLESS OTHERWISE SPECIFIED

1. ALL DIMENSIONS IN INCHES [mm]
- TWO PLACE DECIMALS ±0.02 [0.5]
- THREE PLACE DECIMALS ±0.005 [0.13]

DO NOT SCALE DRAWING

THIS DRAWING DESCRIBES A DESIGN CONSIDERED PROPRIETARY IN NATURE, DEVELOPED AND MANUFACTURED BY SWITCHCRAFT INC. AND IS RELEASED ON A CONFIDENTIAL BASIS FOR IDENTIFICATION PURPOSES ONLY.									
SIZE	WIDTH	MULT	LBS/M	TEMPER					
FINISH SPEC No.					MATERIAL SPEC No.				
FIRST USED ON					SCALE 6:1				
DATE DRAWN	BY	CHKD	APVD						
1/26/22	PC	TJK	TJK						
			1/26/22						
NAME 3.5 MM PHONE JACK SURFACE MOUNT, RoHS					PART No. 35RASMT2BHWNTRX			REV A	

**A: CARRIER SIZE**

- 1. DETAIL SIZE REFERENCES: EIA-481
- 2. SPECIFICATIONS: 24 MM X 16 MM

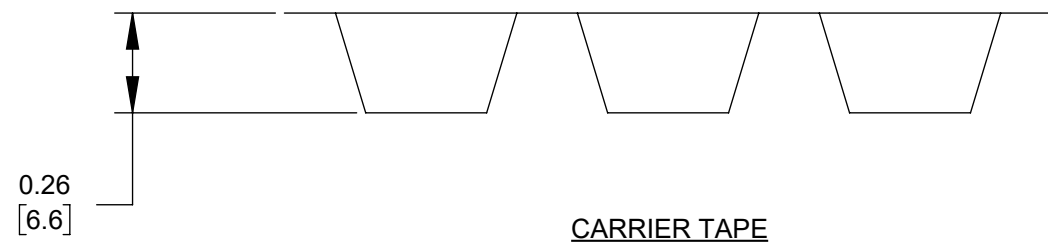
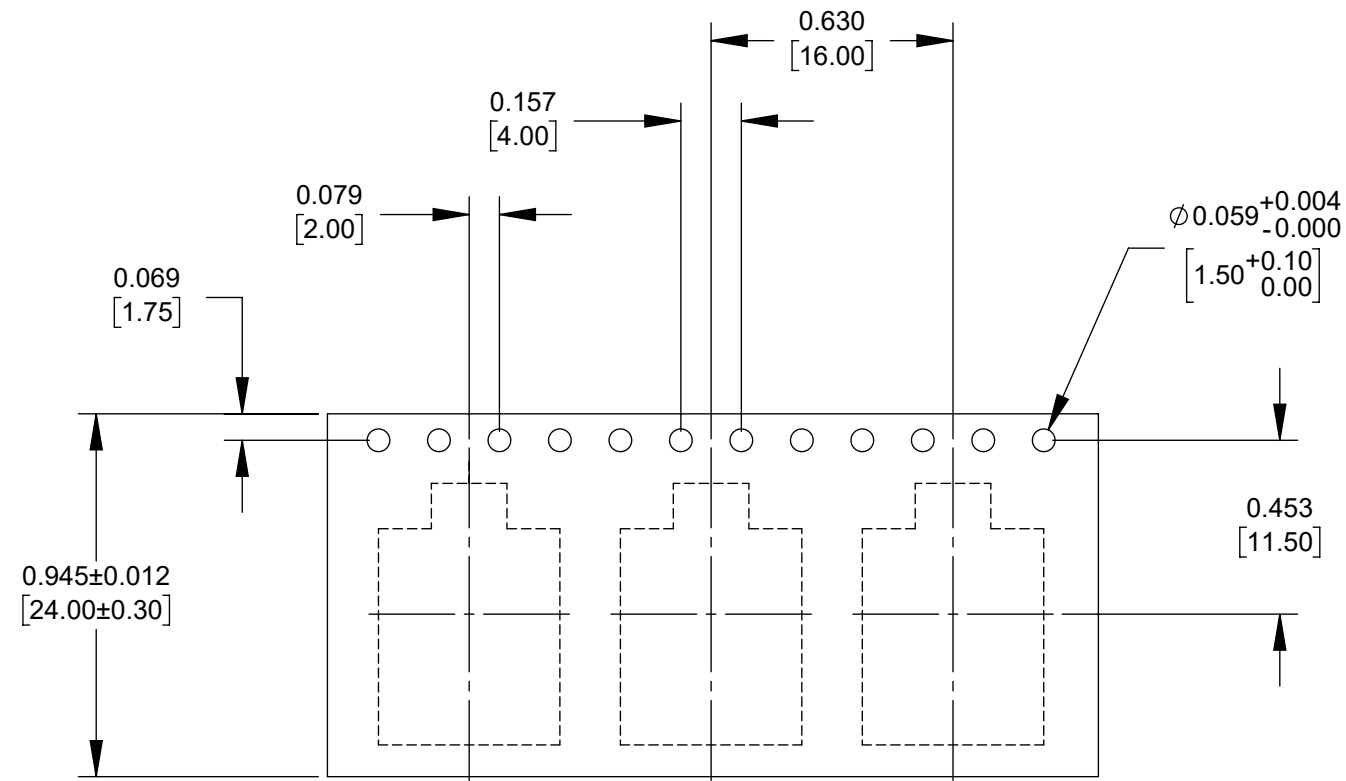

**B: REEL SIZE**

- 1. QUANTITY: 800 PCS/REEL
- 2. MATERIAL: THERMOPLASTIC

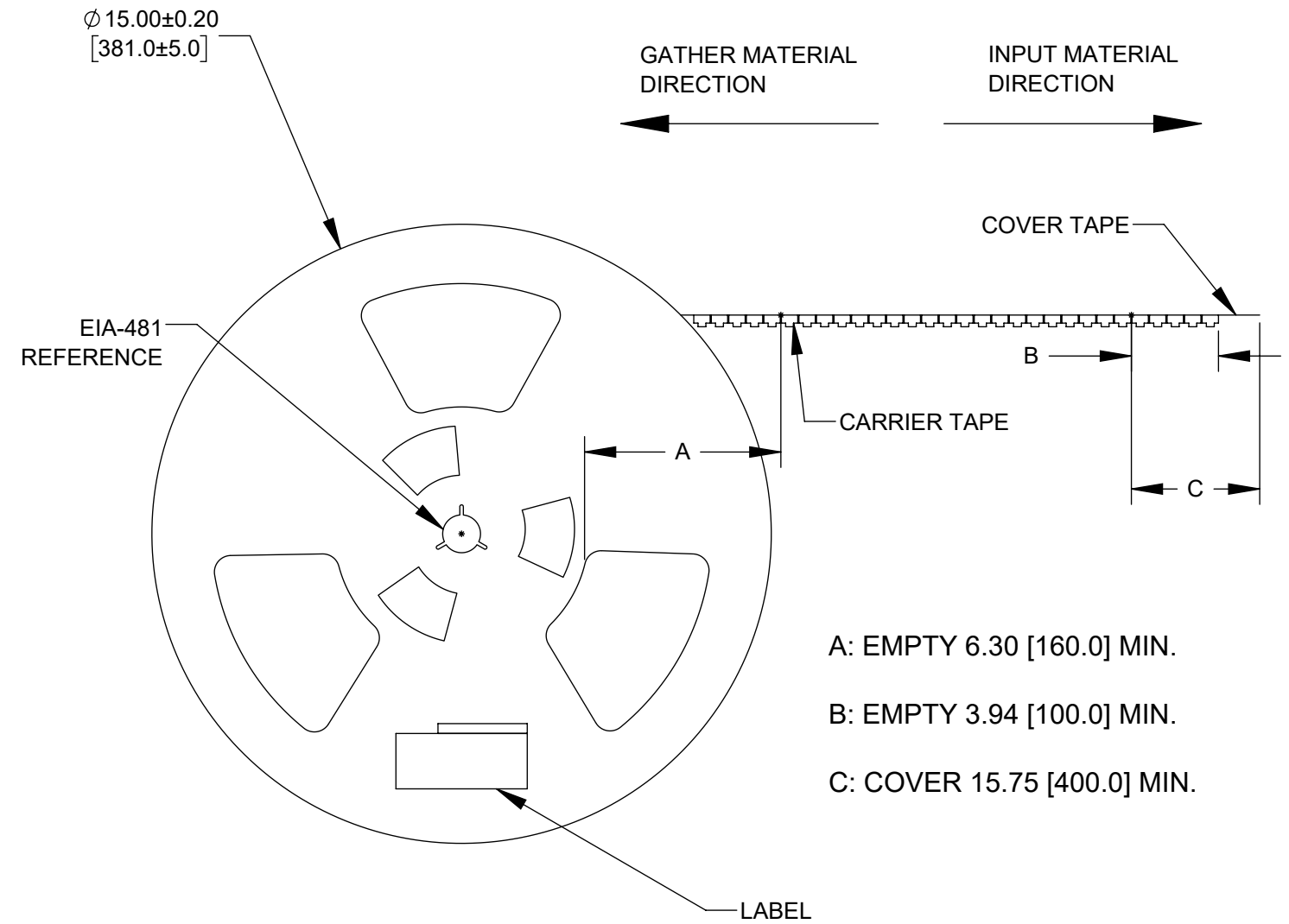

- A: EMPTY 6.30 [160.0] MIN.
- B: EMPTY 3.94 [100.0] MIN.
- C: COVER 15.75 [400.0] MIN.

**CUSTOMER DRAWING**

SCALE 2:1	<b>Switchcraft</b> <sup>®</sup>	
DATE DRAWN 1/22/26		
DRAWN BY PC	PART No. 35RASMT2BHWNTRX	REV A