

CUSTOMER PRINT

PART NUMBER: 8380-XSG-3XX

NOTES:

- ALL PARTS TO BE BULK PACKED.

KIT P/N	NO. OF CONTACTS
8380-2SG-3XX	(2) #16
8380-3SG-3XX	(3) #16
8380-4SG-3XX	(4) #16
8380-XSG-3XX	

GROMMET SIZE FOR SINGLE GROMMET OR "DC" FOR DAISY CHAIN

NO. OF CONTACTS

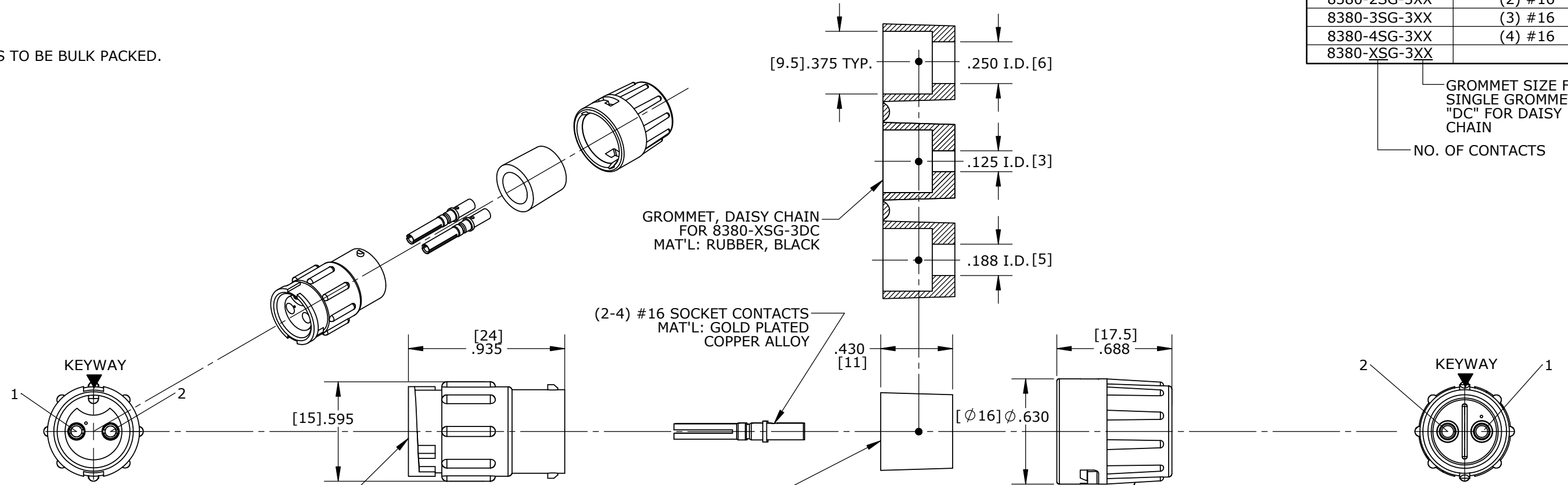

FACE VIEW
8380-2SG-3XX

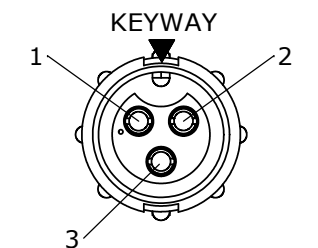

FACE VIEW
8380-3SG-3XX

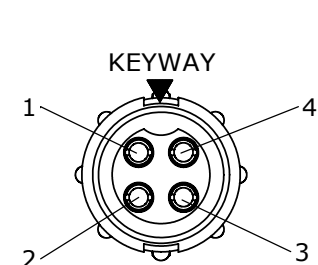

FACE VIEW
8380-4SG-3XX

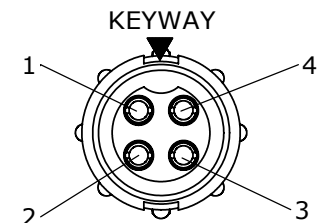

WIRE VIEW
8380-2SG-3XX

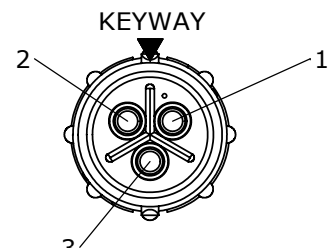

WIRE VIEW
8380-3SG-3XX

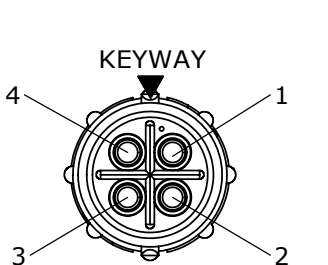

WIRE VIEW
8380-4SG-3XX

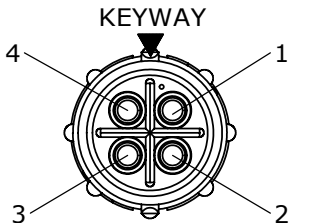

KIT P/N	GROMMET FOR CABLE O.D.
8380-XPG-3DC	DAISY CHAIN
8380-XPG-311	0.09-0.14 [2.3-3.5mm]
8380-XPG-315	0.15-0.17 [3.8-4.3mm]
8380-XPG-318	0.18-0.20 [4.6-5.1mm]
8380-XPG-321	0.21-0.23 [5.3-5.8mm]

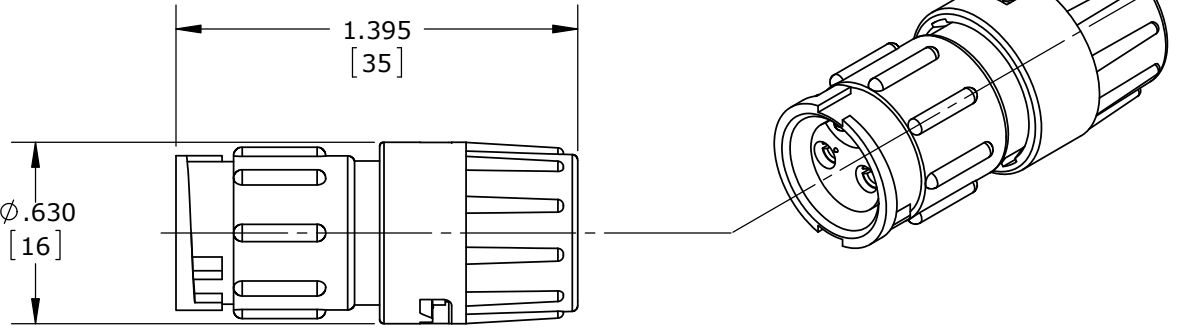

ASSEMBLED VIEWS
FOR CUSTOMER REF.
8380-2SG-3XX SHOWN

CUSTOMER APPROVAL

THIS DOCUMENT CONTAINS CONFIDENTIAL INFORMATION PROPRIETARY TO CONXALL CORPORATION. ANY REPRODUCTION, DISCLOSURE, OR USE OF THIS DOCUMENT /INFORMATION IS EXPRESSLY PROHIBITED UNLESS AUTHORIZED IN WRITING BY CONXALL CORPORATION.

APPROVED BY: _____

DATE: _____

DIMENSIONS IS BRACKETS [] ARE METRIC

RoHS COMPLIANT

A	JD	02-27-17	DRAWING CREATED PER DOR 17-E149SL(5)
REV.	INIT.	DATE	DESCRIPTION
	JD	02-27-17	ALL INFORMATION ILLUSTRATED IS THE PROPERTY OF "CONXALL CORPORATION". UNAUTHORIZED DUPLICATION OR DISTRIBUTION OF THIS DOCUMENT IS PROHIBITED.
			ALL UNITS ARE IN FEET, INCHES, FRACTION OF INCHES AND DECIMALS.
			- CRITICAL CHARACTERISTIC FLAG PER SPEC. XXXX
			ORIG. DRAWN BY: JD DATE: 02-27-17
			CHECKED BY:
			APPROVED BY:
			SCALE: NTS SIZE: B SHEET: 1 OF 1
			FILE: 8380-XSG-3XX DIRECTORY: SLW
			<p>601 E. WILDWOOD VILLA PARK, IL 60181</p>
			<p>TITLE: CABLE TO CABLE CONNECTOR KIT (2-4) #16 SOCKET CONTACTS MINI-CON-X</p> <p>CUSTOMER: STANDARD PRODUCT</p>
			PART NUMBER: 8380-XSG-3XX
			REV A