

CUSTOMER PRINT

PART NUMBER: W16980-XSG-P-5XX

NOTES:

1. ALL PARTS TO BE BULK PACKED
2. CONTACTS SHIPPED UNASSEMBLED
3. ALL DIMENSIONS ARE REFERENCE EXCEPT THOSE WITH A TOLERANCE

ASS'Y P/N	FOR CABLE O.D.
W16980-XSG-P-518	.175-.185 [4.4-4.7]
W16980-XSG-P-521	.205-.215 [5.2-5.5]
W16980-XSG-P-522	.215-.225 [5.5-5.7]

ASS'Y P/N	KEY STYLE	CONTACT QTY.
W16980-5SG-P-5XX	A-KEY	5
W16980-6SG-P-5XX	B-KEY	6
W16980-7SG-P-5XX	A-KEY	7
W16980-XSG-P-5XX		

GROMMET SIZE

NUMBER OF CONTACTS

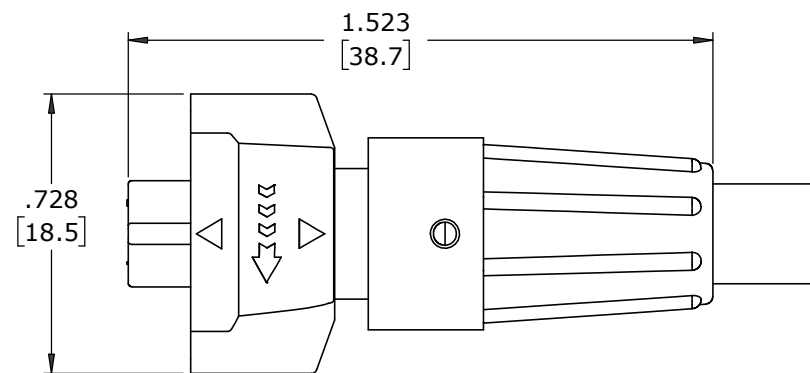

SHOWN ASSEMBLED FOR CUSTOMER REFERENCE ONLY

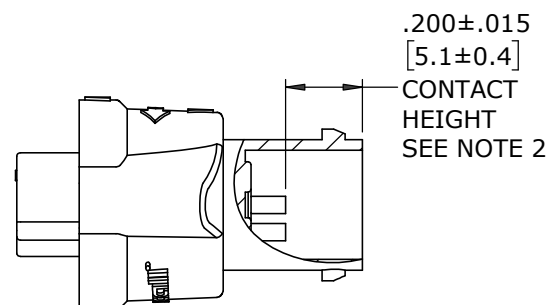

(5-7) #26 SOCKET CONTACTS, CRIMP
MAT'L: GOLD PLATED COPPER ALLOY

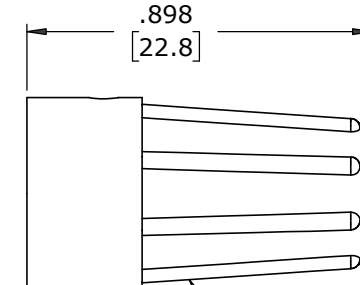
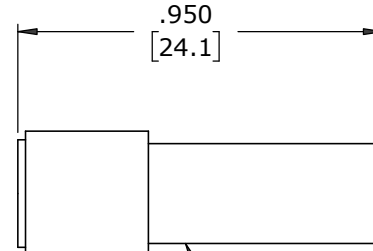
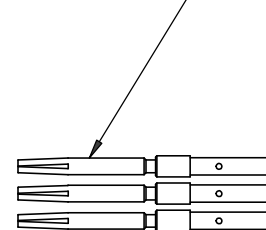
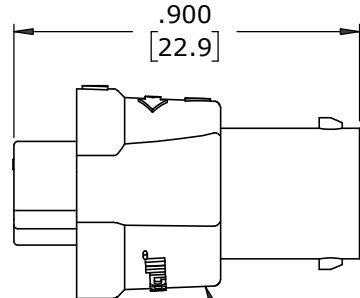

CABLE END HOUSING, FEMALE
MAT'L: UV PBT, BLACK
COUPLING RING
MAT'L: UV PBT, BLACK
O-RING
MAT'L: SILICONE, RED
SPRING
MAT'L: STAINLESS STEEL

GROMMET
MAT'L: RUBBER, BLACK

BACKSHELL
MAT'L: UV PBT, BLACK

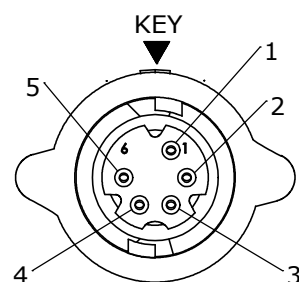

FACE VIEW

W16980-5SG-P-5XX
5 POSITION
A-KEY

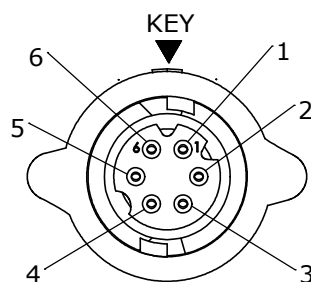

FACE VIEW

W16980-6SG-P-5XX
6 POSITION
B-KEY

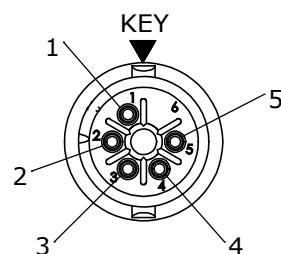

WIRING VIEW

W16980-5SG-P-5XX

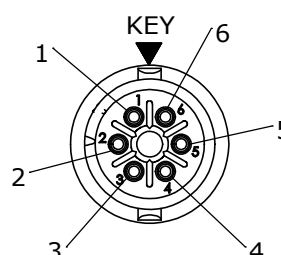

WIRING VIEW

W16980-6SG-P-5XX

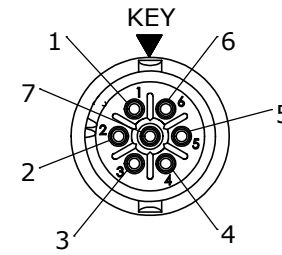

WIRING VIEW

W16980-7SG-P-5XX

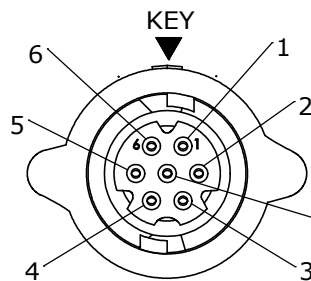

FACE VIEW

W16980-7SG-P-5XX
7 POSITION
A-KEY

CUSTOMER APPROVAL

THIS DOCUMENT CONTAINS CONFIDENTIAL INFORMATION PROPRIETARY TO CONXALL CORPORATION. ANY REPRODUCTION, DISCLOSURE, OR USE OF THIS DOCUMENT /INFORMATION IS EXPRESSLY PROHIBITED UNLESS AUTHORIZED IN WRITING BY CONXALL CORPORATION.

APPROVED BY: _____
DATE: _____

RoHS COMPLIANT

MA	08-18-20	RELEASED PER PDR 18004-4
A	JGK	2/28/20
	JGK	9/09/19
REV.	INIT.	DATE
ALL INFORMATION ILLUSTRATED IS THE PROPERTY OF "CONXALL CORPORATION". UNAUTHORIZED DUPLICATION OR DISTRIBUTION OF THIS DOCUMENT IS PROHIBITED.		ORIG. DRAWN BY: JGK
		DATE: 9/09/19
ALL UNITS ARE IN FEET, INCHES, FRACTION OF INCHES AND DECIMALS. UNLESS OTHERWISE SPECIFIED TOLERANCES: 3 PLACE DECIMALS ±.005 ANGLES ±1° FRACTIONS ±1/16 - CRITICAL CHARACTERISTIC FLAG PER SPEC. XXXX		CHECKED BY:
APPROVED BY:		APPROVED BY:
SCALE	SIZE	SHEET
NTS	B	1 OF 1
FILE:	DIRECTORY:	PART NUMBER:
W16980-XSG-P-5XX	SLW	W16980-XSG-P-5XX
TITLE: CABLE-END ASSEMBLY (5-7) #26 SOCKET CONTACTS, CRIMP INSTA-CLICK™ MICRO-CON-X STANDARD PRODUCT		REV A

DIMENSIONS IN BRACKETS [] ARE METRIC