

CUSTOMER PRINT

PART NUMBER: W3B82-8PG-3XX

- NOTES:
 1. PARTS TO BE BULK PACKED.
 2. SOLDER CONTACTS ARE PRESSED INTO CONNECTOR.
 SIZE 12 CONTACTS AND SIZE 26 (POSITIONS 3, 7 & 8) FACE TOP KEY (UP).
 SIZE 26 CONTACTS (POSITIONS 4-6) FACE DOWN.
 3. ALL DIMENSIONS ARE FOR REFERENCE ONLY EXCEPT WHERE NOTED WITH TOLERANCE.

ASSY P/N	COUPLING RING P/N	CABLE O.D.
W3B82-8PG-335	4282V4	.350-.370 IN. [8.9-9.4mm]
W3B82-8PG-335W	4482V4	.350-.370 IN. [8.9-9.4mm]

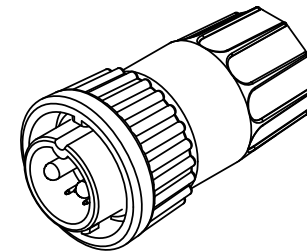

STD COUPLING RING
P/N: W3B82-8PG-3XX

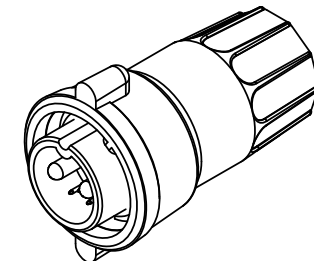

WINGED COUPLING RING
P/N: W3B82-8PG-3XXW

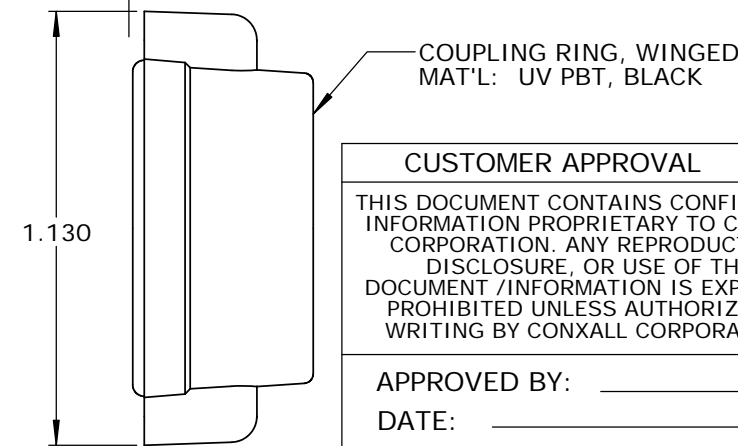
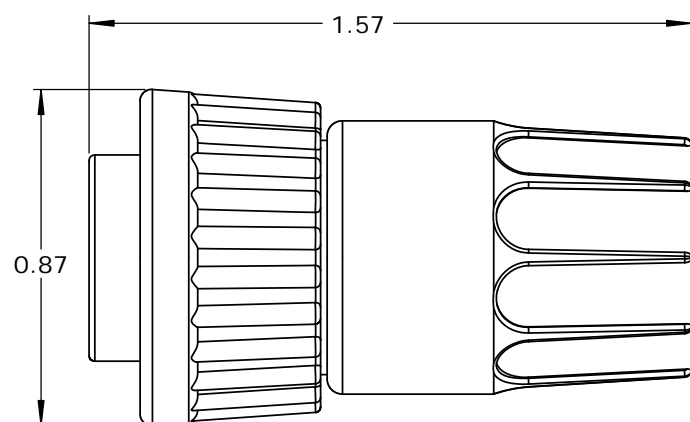
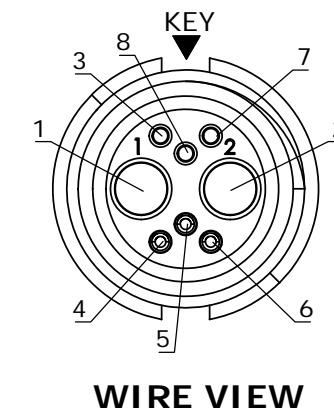
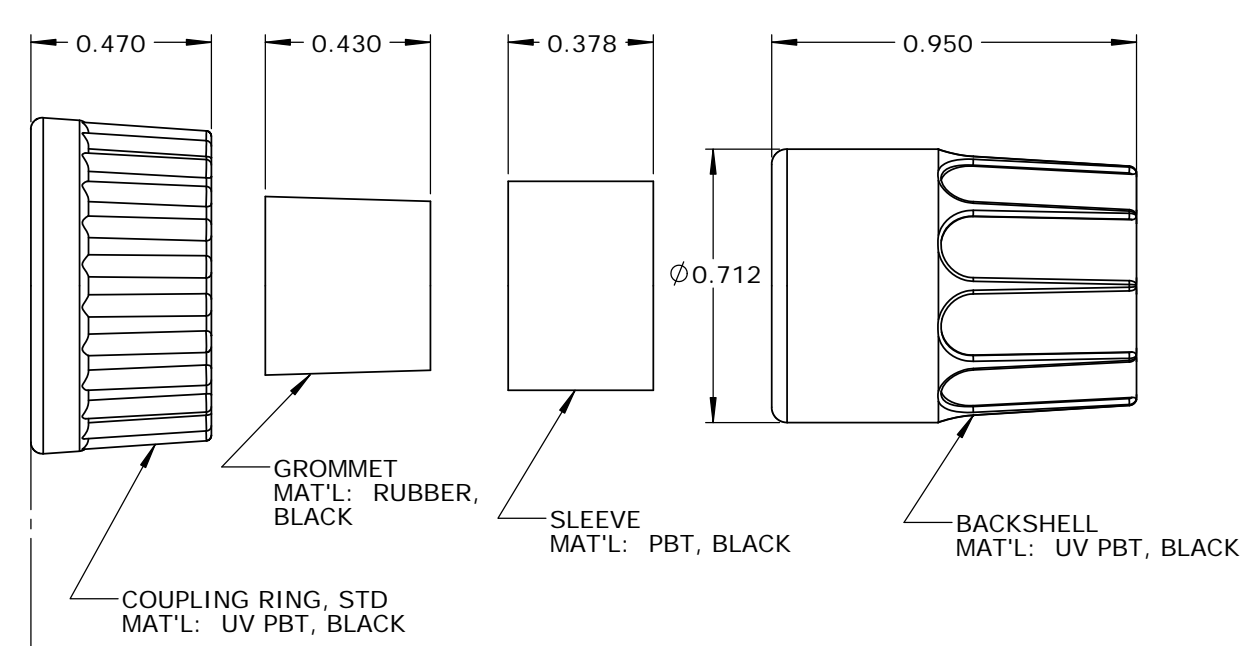
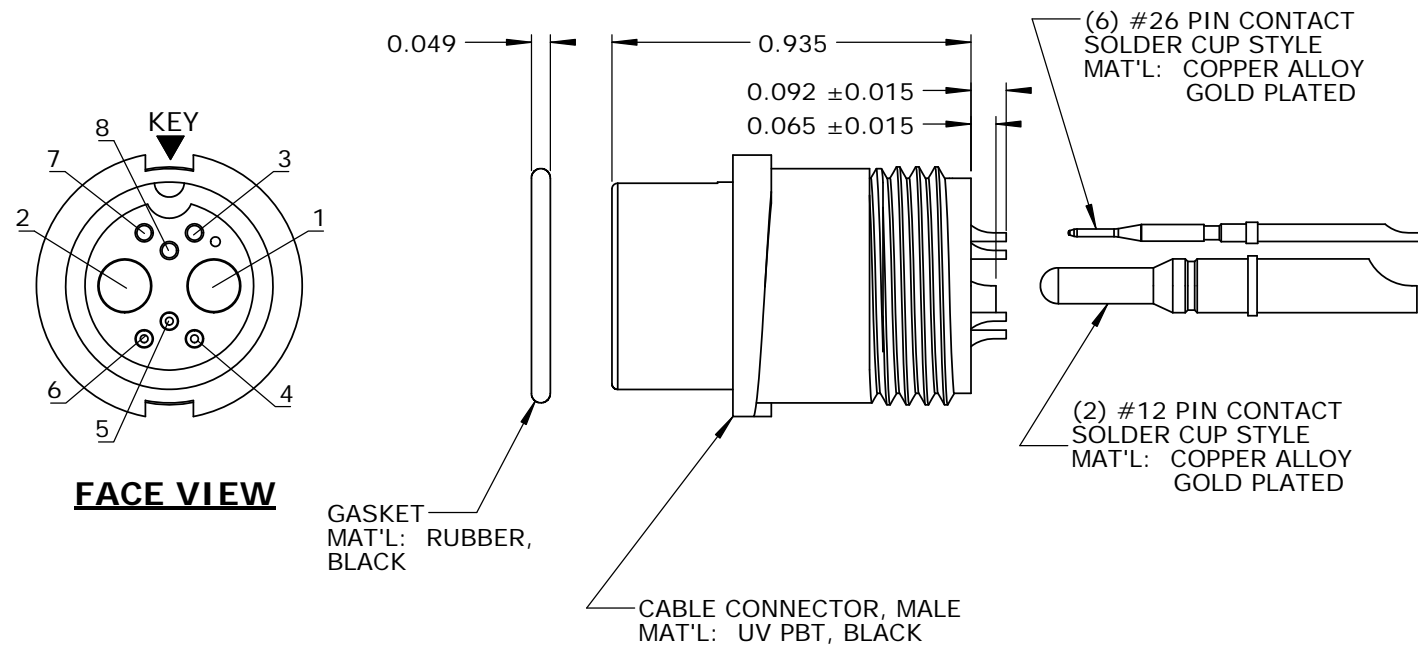

CUSTOMER APPROVAL

THIS DOCUMENT CONTAINS CONFIDENTIAL INFORMATION PROPRIETARY TO CONXALL CORPORATION. ANY REPRODUCTION, DISCLOSURE, OR USE OF THIS DOCUMENT /INFORMATION IS EXPRESSLY PROHIBITED UNLESS AUTHORIZED IN WRITING BY CONXALL CORPORATION.

APPROVED BY: _____
 DATE: _____

RoHS COMPLIANT

A	AB	05-09-19	RELEASE PER DOR 14-6281TC
REV.	INIT.	DATE	DESCRIPTION
ALL INFORMATION ILLUSTRATED IS THE PROPERTY OF "CONXALL CORPORATION". UNAUTHORIZED DUPLICATION OR DISTRIBUTION OF THIS DOCUMENT IS PROHIBITED.		ORIG. DRAWN BY: AB	DATE: 07-21-14
ALL UNITS ARE IN FEET, INCHES, FRACTION OF INCHES AND DECIMALS.		CHECKED BY:	<p>601 E. WILDWOOD VILLA PARK, IL 60181</p>
APPROVED BY:		TITLE: CABLE END CONNECTOR KIT (2)#12 + (6)#26 PIN CONTACTS, SOLDER CUP MULTI-CON-X, WEATHER RESISTANT STANDARD PRODUCT	
SCALE: NTS	SIZE: B	SHEET: 1 OF 1	CUSTOMER: STANDARD PRODUCT
FILE: SAME AS P/N	DIRECTORY: SLW	PART NUMBER: W3B82-8PG-3XX(W)	REV: A