

CUSTOMER PRINT

PART NUMBER: W6282-XSG-P-5XX

NOTES:

1. ALL PARTS TO BE BULK PACKED.
2. SEE DRAWING HPMISTD FOR HOLE PATTERN.
3. ALL DIMENSIONS ARE REFERENCE ONLY. DIMENSIONS IN [] ARE METRIC.

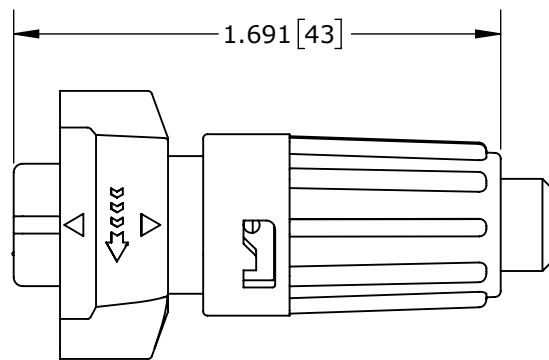

SHOWN ASSEMBLED KIT
ASSY: W6282-2SG-P-5XX SHOWN

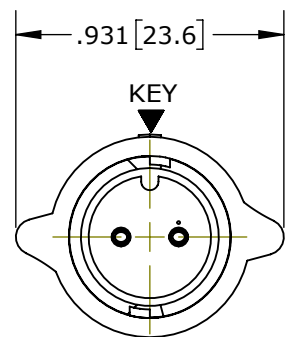

MATING FACE
ASSY: W6282-2SG-P-5XX SHOWN

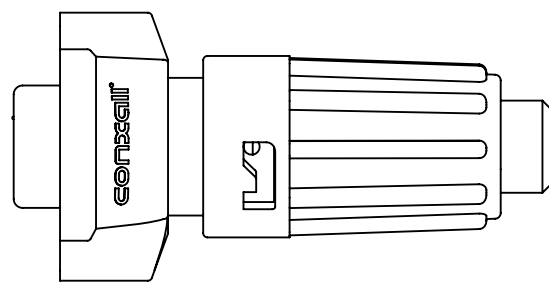
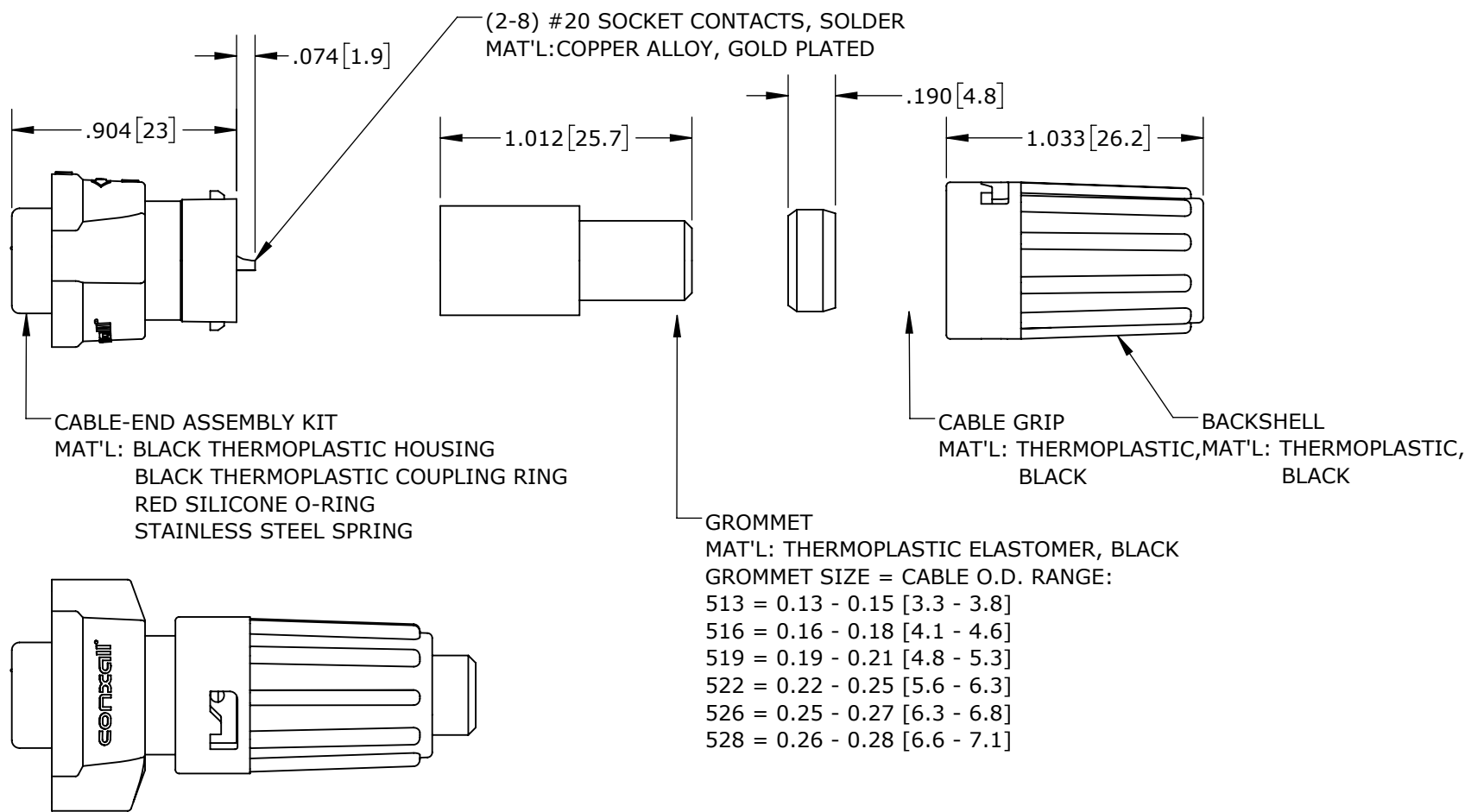

SHOWN ASSEMBLED KIT
ASSY: W6282-2SG-P-5XX SHOWN

CABLE-END CONNECTOR P/N	CONTACTS
W6282-2SG-P-5XX	2 #20
W6282-3SG-P-5XX	3 #20
W6282-4SG-P-5XX	4 #20
W6282-5SG-P-5XX	5 #20
W6282-6SG-P-5XX	6 #20
W6282-7SG-P-5XX	7 #20
W6282-8SG-P-5XX	8 #20
W6282-XSG-P-5XX	

GROMMET SIZE

NUMBER OF CONTACTS

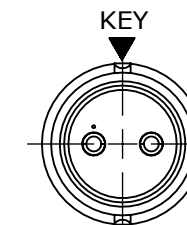

WIRING END
ASSY: W6282-2SG-P-5XX SHOWN
WITHOUT HARDWARE

CUSTOMER APPROVAL

THIS DOCUMENT CONTAINS CONFIDENTIAL INFORMATION PROPRIETARY TO CONXALL CORPORATION. ANY REPRODUCTION, DISCLOSURE, OR USE OF THIS DOCUMENT / INFORMATION IS EXPRESSLY PROHIBITED UNLESS AUTHORIZED IN WRITING BY CONXALL CORPORATION.

APPROVED BY: _____

DATE: _____

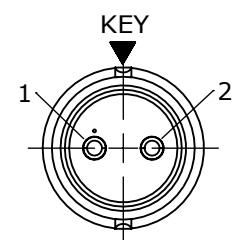

WIRING END
W6282-2SG-P-5XX

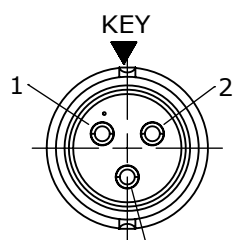

WIRING END
W6282-3SG-P-5XX

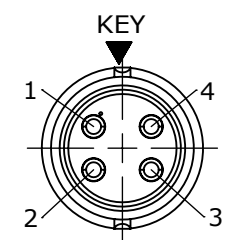

WIRING END
W6282-4SG-P-5XX

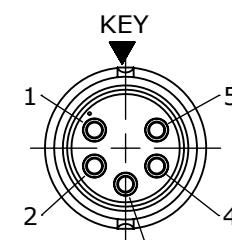

WIRING END
W6280-5SG-P-5XX

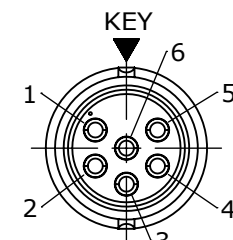

WIRING END
W6282-6SG-P-5XX

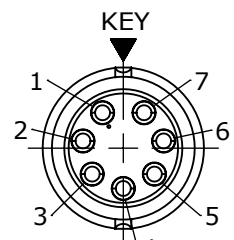

WIRING END
W6282-7SG-P-5XX

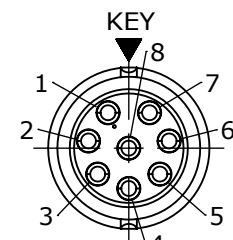

WIRING END
W6282-8SG-P-5XX

RoHS COMPLIANT

0A	PNK	01-15-18	PDR 16014
REV.	INIT.	DATE	DESCRIPTION
			ORIG. DRAWN BY: DATE: 01-15-18
<p>ALL INFORMATION ILLUSTRATED IS THE PROPERTY OF CONXALL CORPORATION. UNAUTHORIZED REPRODUCTION OR DISTRIBUTION OF THIS DOCUMENT IS PROHIBITED.</p> <p>ALL UNITS ARE IN FEET, INCHES, FRACTION OF INCHES AND DECIMALS. UNLESS OTHERWISE SPECIFIED TOLERANCES: 3 PLACE DECIMALS ±0.010 ANGLES ±1° FRACTIONS ±1/16</p> <p>▽ - CRITICAL CHARACTERISTIC FLAG PER SPEC. XXXX</p>			
<p>CHECKED BY:</p>		<p>APPROVED BY:</p>	
<p>SCALE: NTS</p>		<p>SHEET: 1 OF 1</p>	
<p>FILE: W6282-XSG-P-5XX</p>		<p>DIRECTORY: SLW</p>	
<p>TITLE: CABLE-END ASSEMBLY 2-8 #20 SOCKET CONTACTS, SOLDER INSTA-CLICK™ MINI-CON-X</p>			<p>CUSTOMER: STANDARD PRODUCT</p>
<p>PART NUMBER: W6282-XSG-P-5XX</p>			<p>REV 0A</p>



601 E. WILDWOOD VILLA PARK, IL 60181