

CUSTOMER PRINT

PART NUMBER: W6380-XSG-P-3XX

NOTES:

1. ALL PARTS TO BE BULK PACKED.
2. SEE DRAWING HPMISTD FOR HOLE PATTERN.
3. ALL DIMENSIONS ARE REFERENCE ONLY. DIMENSIONS IN [] ARE METRIC.

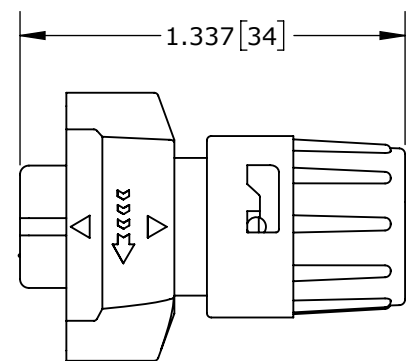

SHOWN ASSEMBLED KIT
ASSY: W6380-2SG-P-3XX SHOWN

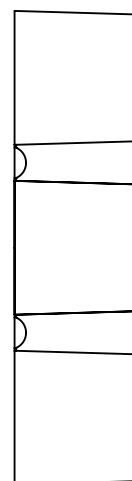

DAISY CHAIN GROMMETS (3DC)
.125 I.D. FOR CABLES .09-.14 [2.3 - 3.6] O.D.
.188 I.D. FOR CABLES .18-.20 [4.6 - 5.1] O.D.
.250 I.D. FOR CABLES .24-.26 [6.1 - 6.6] O.D.

CABLE-END CONNECTOR P/N	CONTACTS
W6380-2SG-P-3XX	2 #16
W6380-3SG-P-3XX	3 #16
W6380-4SG-P-3XX	4 #16
W6380-5SG-P-3XX	5 #16
W6380-XSG-P-3XX	

GROMMET SIZE:
3DC FOR DAISY CHAIN GROMMETS
3XX FOR SINGLE GROMMET SIZE PER LIST ON THIS DRAWING.

NUMBER OF CONTACTS

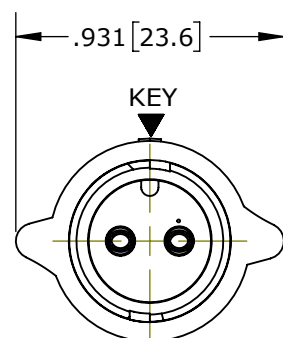

MATING FACE
ASSY: W6380-2SG-P-3XX SHOWN

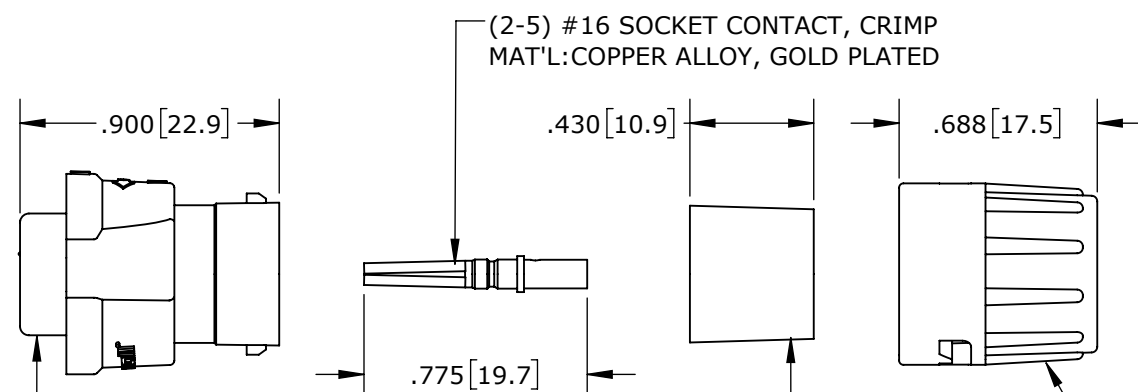

CABLE-END ASSEMBLY KIT
MAT'L: BLACK THERMOPLASTIC HOUSING
BLACK THERMOPLASTIC COUPLING RING
RED SILICONE O-RING
STAINLESS STEEL SPRING

BACKSHELL
MAT'L: THERMOPLASTIC, BLACK

GROMMET
MAT'L: THERMOPLASTIC ELASTOMER, BLACK
GROMMET SINGLE SIZE = CABLE O.D. RANGE:
311: .125 I.D. FOR CABLES .09-.14 [2.3 - 3.6] O.D.
315: .156 I.D. FOR CABLES .15-.17 [3.8 - 4.3] O.D.
318: .188 I.D. FOR CABLES .18-.20 [4.6 - 5.1] O.D.
321: .225 I.D. FOR CABLES .21-.23 [5.3 - 5.8] O.D.

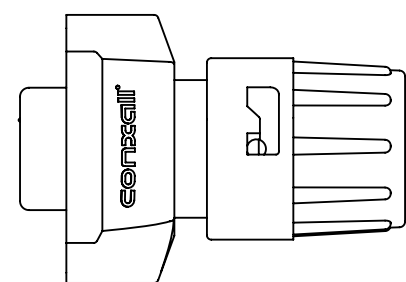

SHOWN ASSEMBLED KIT
ASSY: W6380-2SG-P-3XX SHOWN

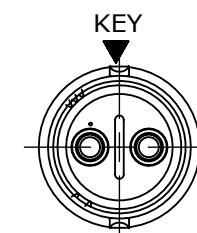

WIRING END
ASSY: W6380-2SG-P-3XX SHOWN WITHOUT HARDWARE

CUSTOMER APPROVAL

THIS DOCUMENT CONTAINS CONFIDENTIAL INFORMATION PROPRIETARY TO CONXALL CORPORATION. ANY REPRODUCTION, DISCLOSURE, OR USE OF THIS DOCUMENT / INFORMATION IS EXPRESSLY PROHIBITED UNLESS AUTHORIZED IN WRITING BY CONXALL CORPORATION.

APPROVED BY: _____

DATE: _____

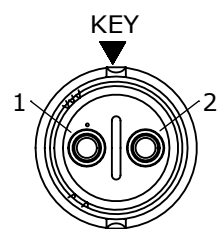

WIRING END
W6380-2SG-P-3XX

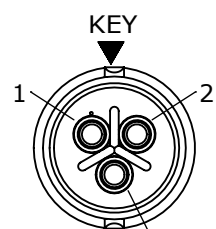

WIRING END
W6380-3SG-P-3XX

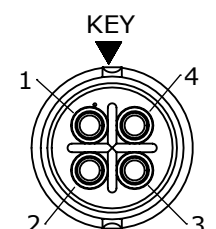

WIRING END
W6380-4SG-P-3XX

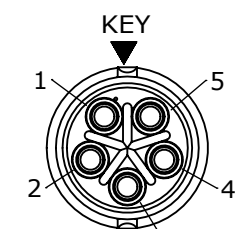

WIRING END
W6380-5SG-P-3XX

RoHS COMPLIANT

0A	PNK	05-10-19	PDR 16014
REV.	INIT.	DATE	DESCRIPTION
			ORIG. DRAWN BY: PNK DATE: 05-10-19
ALL INFORMATION ILLUSTRATED IS THE PROPERTY OF CONXALL CORPORATION. UNAUTHORIZED DUPLICATION OR DISTRIBUTION OF THIS DOCUMENT IS PROHIBITED.			<p>601 E. WILDWOOD VILLA PARK, IL 60181</p>
UNLESS OTHERWISE SPECIFIED TOLERANCES: 3 PLACE DECIMALS ±0.10 ANGLES ±1° FRACTIONS ±1/16			
APPROVED BY:		TITLE: CABLE-END ASSEMBLY 2-5 #16 SOCKET CONTACTS, CRIMP INSTA-CLICK™ MINI-CON-X	
SCALE: NTS	SIZE: B	SHEET: 1 OF 1	CUSTOMER: STANDARD PRODUCT
FILE: W6380-XSG-P-3XX	DIRECTORY: SLW	PART NUMBER: W6380-XSG-P-3XX	REV: 0A